

# Sealing Tapes

P.V.C Waterstops

Hydrophilic Waterstops



# Waterseal®

## High Quality P.V.C. Waterstops

### Description

The wide range of P.V.C waterstops are designed to provide an integral sealing system for movement and construction joints in concrete cast in-situ. These joints typically occur in the following types of structure.

### Typical Applications

For Construction and Expansion Joints, all Types of Joints in Transitions, Connections and Special Applications.

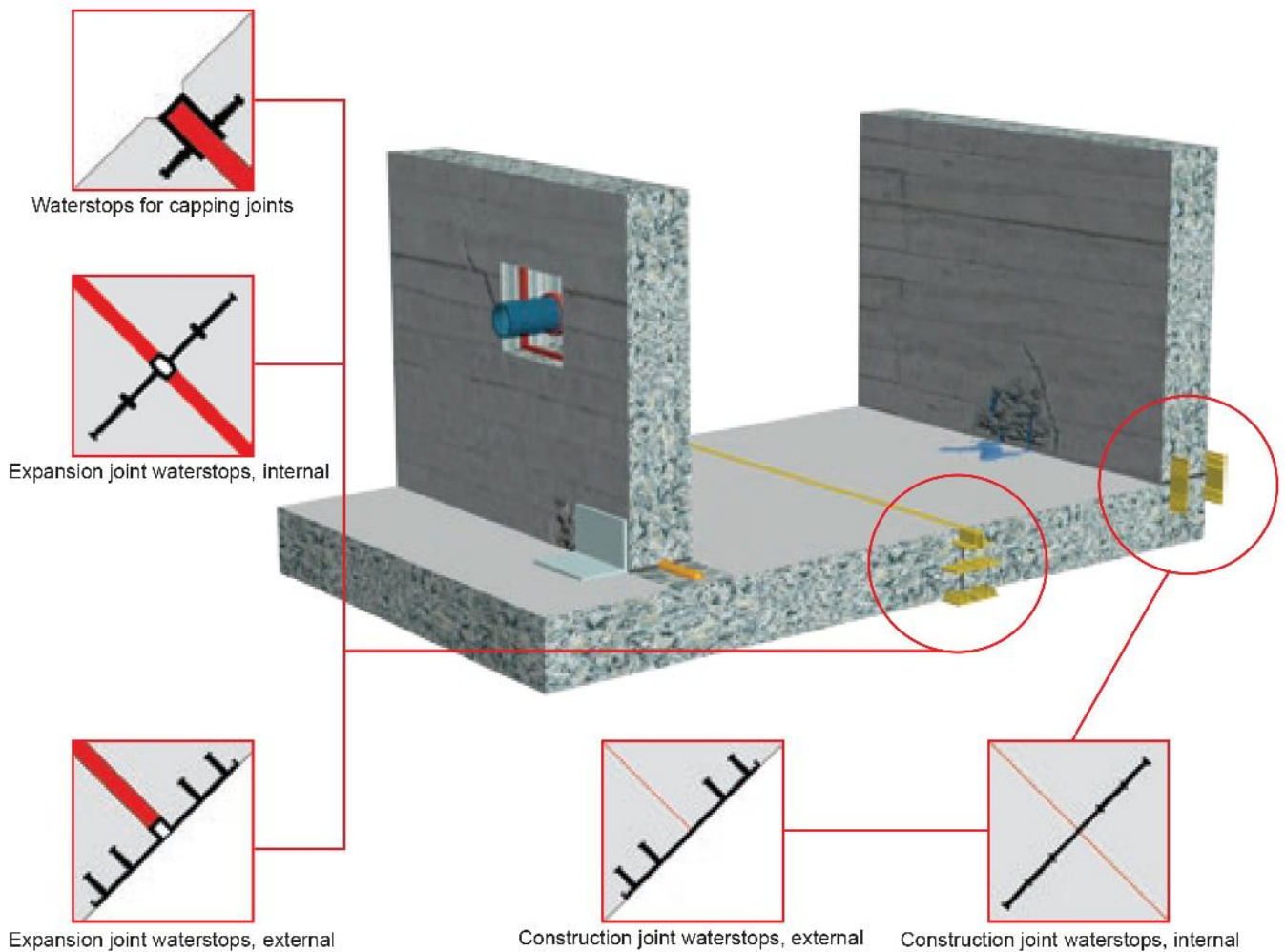

## Choose waterstops based on the type of joint

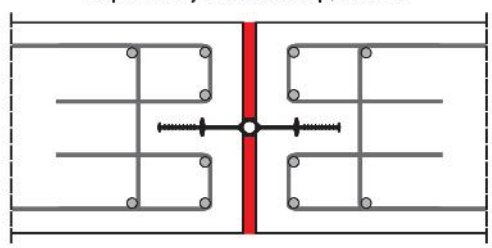
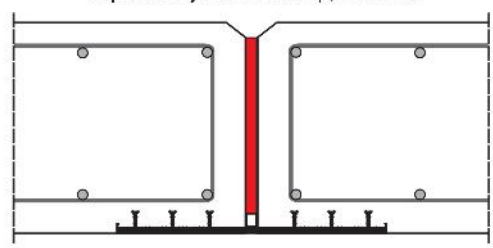
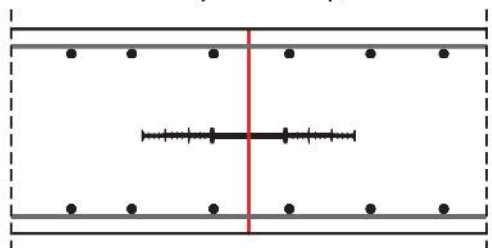
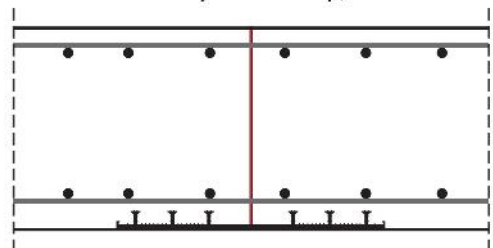
Type of Joint	Type of Waterstop	
Expansion Joints	<p>Expansion joint waterstop, internal</p> 	<p>Expansion joint waterstop, external</p> 
Construction Joints	<p>Construction joint waterstop, internal</p> 	<p>Construction joint waterstop, external</p> 

## Waterstop Design and Function

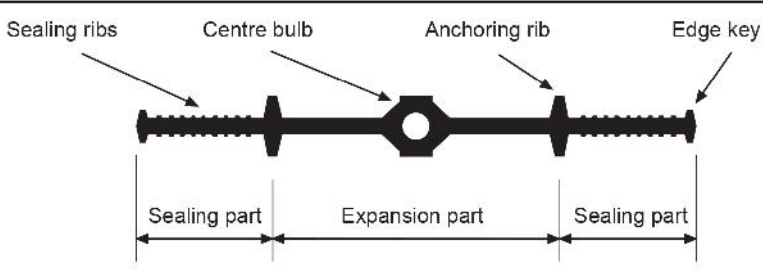
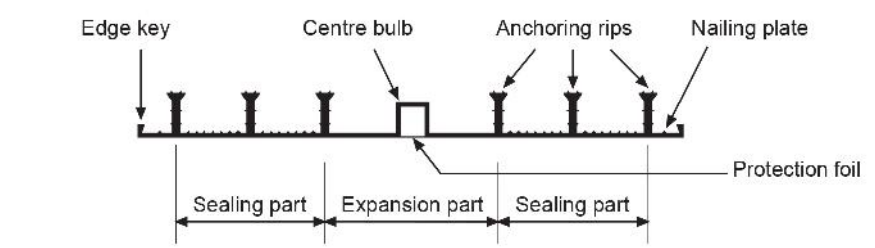
Type of waterstop	Waterstop Design and Function
Expansion joint waterstop, internal	
Expansion joint waterstop, external	

## Standards compliance

Waterseal produced in accordance with the requirements of DIN 18541 Part 2 (Physical Properties) and DIN 18541 Part 1 (Dimensional Properties).

### Physical Properties:

Physical Properties (DIN 18541 Part 2)			
No.	Property	DIN Standard	Requirement
1	Tensile strength in N/mm <sup>2</sup>	53455	≥10
2	Elongation at break in %	53455	≥350
3	Shore Hardness	53505	67±5
4	Tear strength in N/mm <sup>2</sup>	53507	≥12
5	Behaviour at low temperatures (-20°C), Elongation at break in N/mm <sup>2</sup>	53455	≥200
6	Behaviour after storage on bitumen (28 days / 70°C)	53455	≥±20
	Change in %: Tensile strength	53455	≥±20
	Elongation at break	53455	≥±50
	Modulus of elasticity		

### Dimensional Properties:

#### - Type D waterstops

Figure 1: Typical cross section of type D waterstops

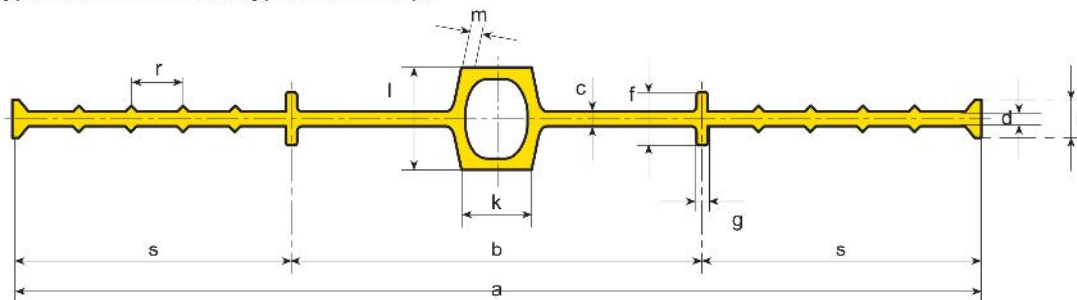

Table 1: Minimum dimensions of type D waterstops

Width			Thickness		Profiling			Channel / Loop		
a	b	s	c	d <sup>1</sup>	f	g	i	k	l	m
190	70	-	2/5	-	15	≥ C	11 ≥ d+6	10	25	3
240	80	62/5	4	3	≥ 3C			20	30	3/5
320	100	75	5	3/5	18			45	35	4
500	150	100	6	4/5	≥ 3C			45	45	4/5

<sup>1)</sup> The thickness of the sealing flanks shall be the same as that of the central web where they meet, but may decrease to *d* at the edges.

#### Key to symbols used in figure 1 and table 1:

- |                                                  |                                                                |
|--------------------------------------------------|----------------------------------------------------------------|
| a. overall width                                 | g. thickness of anchor ribs at the root (tangent intersection) |
| b. width of central web                          | i. thickness of edge reinforcement                             |
| c. thickness of central web at thinnest point    | k. width of channel of loop                                    |
| d. thickness of sealing flanks at thinnest point | l. height of channel or loop                                   |
| f. height of anchor ribs, measured on both sides | m. wall thickness of channel or loop at narrowest point        |

### - Type A waterstops

Figure 2: Typical cross section of type A waterstops

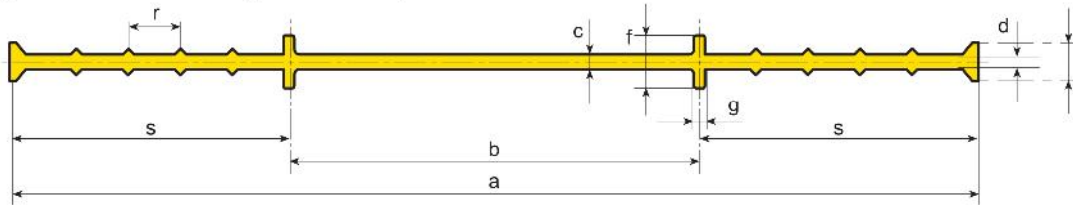

Table 2: Minimum dimensions of type A waterstops

Width			Thickness		Profiling		
a	b	s	c	d <sup>1</sup>	f	g	i
240	80	62/5	3/5	2/5	15	≥ c	11 ≥ d+6
320	100	75	4/5	3	≥ 3c		
500	150	100	6	3/5	18 ≥ 3c		

<sup>1)</sup> The thickness of sealing flanks shall be of the same thickness c as the central web where the two parts meet but may be reduced to d towards the edge.

#### Key to symbols used in figure 2 and table 2:

- a. overall width
- b. width of central web
- c. thickness of central web at thinnest point
- d. thickness of sealing flanks at thinnest point
- f. height of anchor ribs, measured on both sides
- g. thickness of anchor ribs at the root (tangent intersection)
- i. thickness of edge reinforcement

### - Type DA waterstops

Figure 3: Typical cross section of type DA waterstops

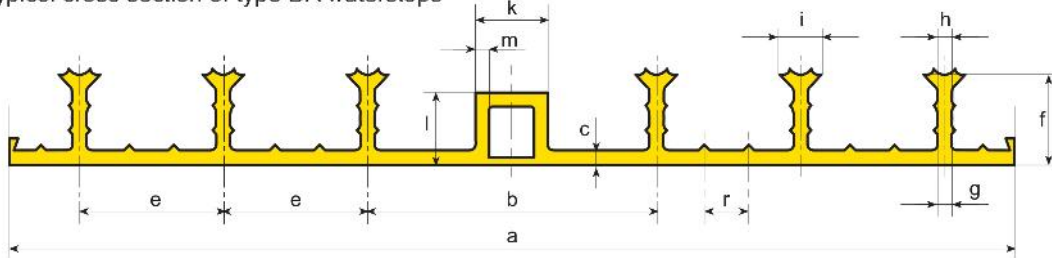

Table 3: Minimum dimensions of type DA waterstops

Width		Thickness	Profiling							Channel / Loop		
a	b	c	N	e	f	f <sub>1</sub> *	g	h	i	k	l	m
240	90	4	4	45	20	16	4 ≥ c ≥ 0.2 f	4	11 l ≥ h+6	20	20	4
320	100		6		25	21						
500	120		8		25	21						

\* f<sub>1</sub> ≥ f - c

#### Key to symbols used in figure 3 and table 3:

- a. overall width
- b. width of central web
- c. thickness of strip
- e. axial spacing of anchor blocks
- f. height of anchor block
- g. thickness of anchor block at root
- h. thickness of anchor block at narrowest point
- i. thickness of reinforcement at anchor block
- k. width of channel or loop
- l. height of channel or loop
- m. wall thickness of channel or loop at narrowest point
- N. number of anchor blocks
- r. no smaller than 10 mm.



### - Type AA waterstops

Figure 4: Typical cross section of type AA waterstops

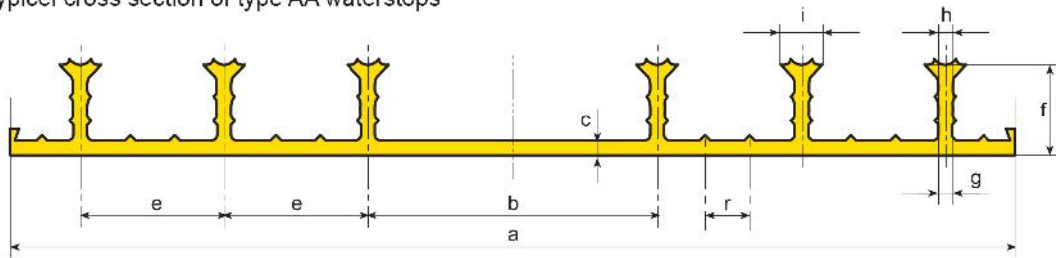

Table 4: Minimum dimensions of type AA waterstops

Width		Thickness	Profiling						
a	b	c	N	e	f	f <sub>1</sub> *	g	h	i
240	90	4	4	45	20	16	4 ≥ c ≥ 0.2 f	4	11 i ≥ h+6
320	100		6		25	21			
500	120		8		25	21			

\* f<sub>1</sub> ≥ f - c

Key to symbols used in figure 3 and table 3:

- a. overall width
- b. width of central web
- c. thickness of strip
- e. axial spacing of anchor blocks
- f. height of anchor block
- g. thickness of anchor block at root
- h. thickness of anchor block at narrowest point
- i. thickness of reinforcement at anchor block
- N. number of anchor blocks
- r. no smaller than 10 mm.

### Waterstop Selection in Accordance with Water Pressure

According to the EM1110-02-2012 standard (Relate to US Corps of Engineers) P.V.C. waterstop thickness is obtained based on the following chart:

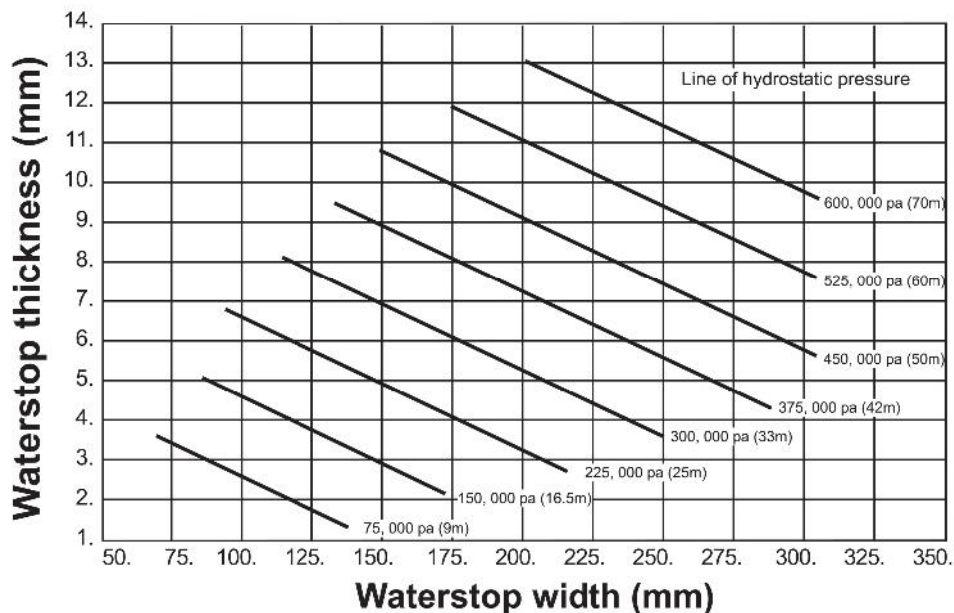

## CAPCO P.V.C. Waterstops

### Waterseal<sup>®</sup> D

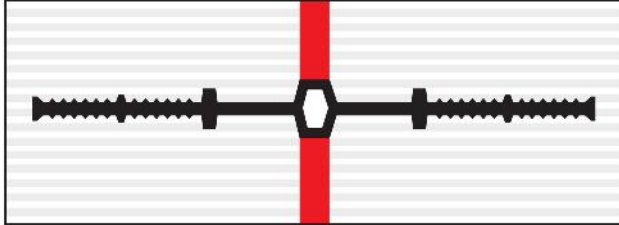

Expansion joint waterstops, internal

Model	Thickness (mm)	Head of Water (m)
Waterseal D150	2.5	8
Waterseal D170	2.5	10
Waterseal D190	2.5	16
Waterseal D240	4	23
Waterseal D300	5	50
Waterseal D300	8	60
Waterseal D320	5	55
Waterseal D400	8	70

### Waterseal<sup>®</sup> A

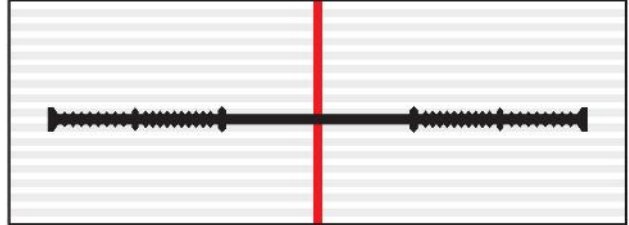

Construction joint waterstops, internal

Model	Thickness (mm)	Head of Water (m)
Waterseal A150	2.5	7.6
Waterseal A170	2.5	10
Waterseal A190	2.5	16
Waterseal A240	3.5	23
Waterseal A300	4	45
Waterseal A320	4.5	50

### Waterseal<sup>®</sup> DA



Expansion joint waterstops, external

Model	Thickness (mm)	Head of Water (m)
Waterseal DA 240	4	23
Waterseal DA 300	4	60
Waterseal DA 500	4	80

### Waterseal<sup>®</sup> AA

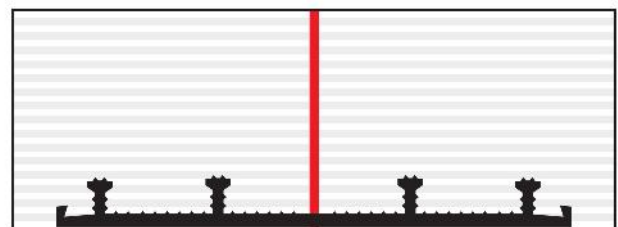

Construction joint waterstops, external

Model	Thickness (mm)	Head of Water (m)
Waterseal AA 240	4	23
Waterseal AA 300	4	50
Waterseal AA 500	4	80

## Tailor-Made Waterstops

P.V.C. waterstop can be manufactured according to customer orders with different dimensions.

## Waterstop Specification

### Design:

#### - Closed Waterproofing System

Waterstops must create a closed waterproofing system within the reinforced concrete structure. Joint intersections with each other and with penetrations and edges of the structure should be made as square as possible. The clearance from the edges of the structure should generally be 0.5 m minimum. The overall waterstop section system specification and method statement for a project are divided into logical sections. These are linked to the drawings of the system and its components, their factory prefabrication or assembly and for their installation on site. This also provides part of the project documentation and confirmation of the specific waterstop qualities required. The waterstops should conform with the local regulations and specifications.

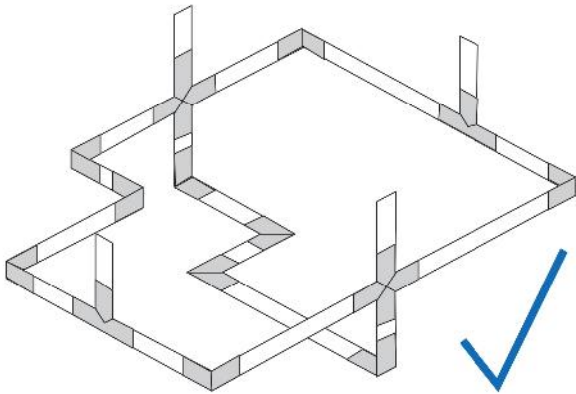

#### - Waterstop Width Rule



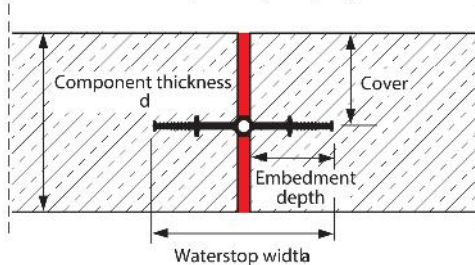

The component thickness  $d$  around internal waterstops should be at least equivalent to the waterstop width  $a$  (embedment depth  $\leq$  cover). A component thickness of 300 mm is sufficient for 320 mm wide waterstops according to DIN 18541 (types D and A). The choice of waterstops is based on the load and exposure, e.g. in accordance with DIN V18197. Our Product Engineering department will be pleased to assist you in your projects.

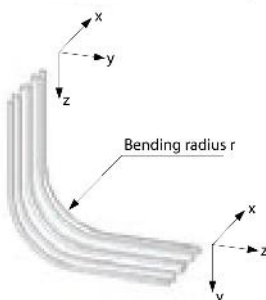

#### - Bending Radius $r$

When there are changes of direction perpendicular to the waterstop level, waterstops may be bended strictly regarding the indicated minimum bending radius  $r$ . If the required bending radius  $r$  cannot be maintained, a factory-made vertical angle should be specified.



Bending radius $r$	
	$\geq 25 \text{ cm}$
	$\geq 15 \text{ cm}$
	$\geq 50 \times \text{Stop anchor depth } f$ (Example: $f = 30 \text{ mm} \rightarrow r \geq 1,50 \text{ m}$ )
	$\geq 30 \times \text{Profilhöhe } a$ (Example: $a = 70 \text{ mm} \rightarrow r \geq 2,10 \text{ m}$ )
Otherwise	
Mitred angled joint (factory made joint)	

#### - Concrete and Reinforcement Cover

The clearance between waterstop and reinforcement shall be at least 20 mm.

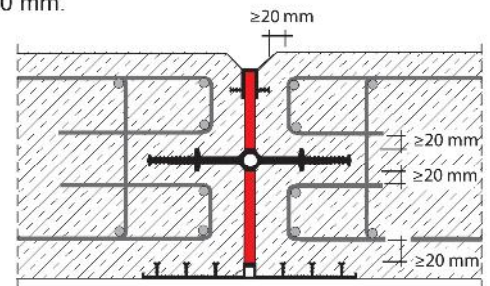

#### - Horizontal Waterstop Installation in Slabs

Internal waterstops in horizontal base or deck slabs should be installed in a v-shape at an angle of about  $15^\circ$  upwards, to allow the waterstop sides to be embedded without voids and to prevent concrete honeycombing (from grout loss / segregation during concreting).

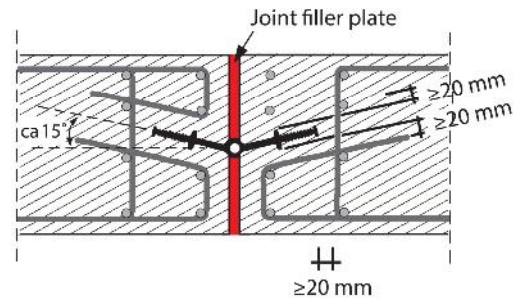

#### - Use of External Waterstops

External waterstops are always fitted on the water contact side. They must not be casted in on the top of horizontal and low angled components (due to the risk of air entrapment and voids). External waterstops must be given adequate durable protection against mechanical damage (e.g. by backfilling with soil, sand, similar fillers without angular crushed stone).

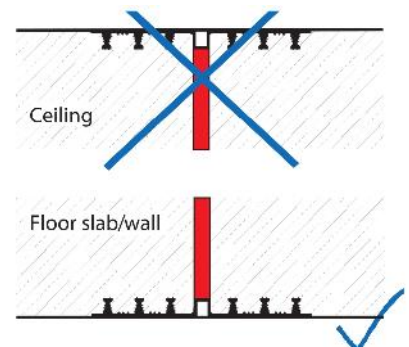



## Waterstop Handling Guidelines

### Storage:

#### - Protected Storage

When delivered to site, the waterstop products must be unloaded carefully and inspected immediately for completeness and integrity, including form and dimensions. Before installation the waterstops must be kept in a sheltered place on boards or some other firm base (e.g. pallets, concrete surfaces) and protected from contamination or damage.

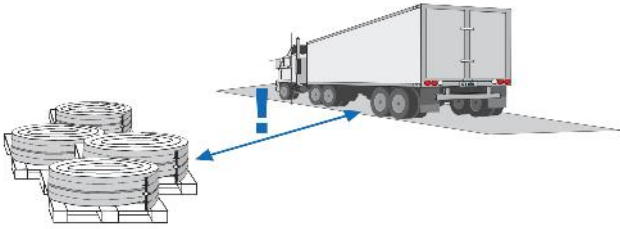

#### - Storage in Summer

Waterstops must be protected from direct sunlight, specially in summer, e.g. by covering. In high outside temperatures waterstops must be taken to the point of installation and laid out under no tension.

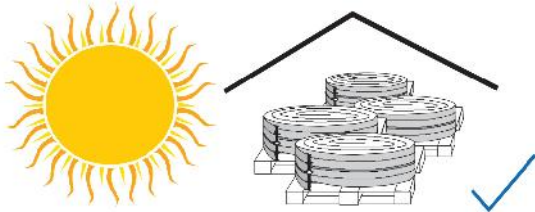

#### - Storage in Winter

Waterstops should be kept in covered storage if possible and then be put in heated rooms for at least one full day prior to their installation, to make their handling and installation easier and less prone to damage (thermoplastic material).

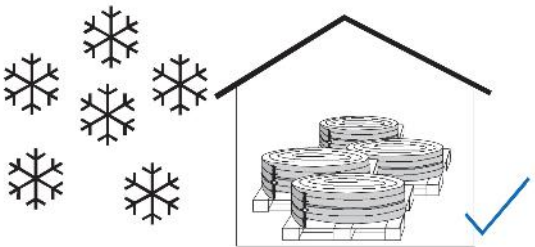

## Waterstop Installation Guidelines

### Installation and Fixing:

#### - Cleanliness and Integrity

Waterstops must not be installed if they have suffered deformation or damage which might impair their function. Waterstops must be installed without creasing or distortion. Deformation in external waterstops caused during storage or handling (e.g. creasing or distortion of the anchors) should be corrected by stretching on a level base and heat treatment. Waterstops can only be installed at a material temperature of over  $\pm 0^{\circ}\text{C}$  and in weather conditions not endangering the safe installation of the whole waterproofing system.

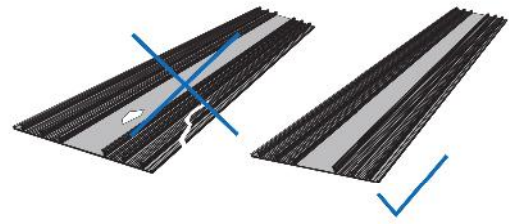

#### - Fixed in a Stable Position

Waterstops should be installed in their specified position, symmetrical to the joint axis, and be fixed so that their position can not change or move during the concreting works.

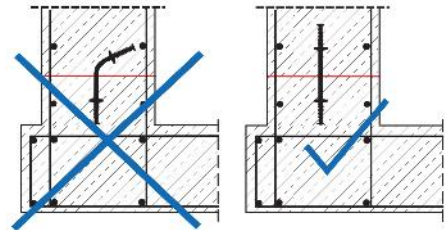

## Waterstop Installation Guidelines on Site

### During the Waterstop Installation:

#### - Fixing Internal Waterstops

Internal waterstops are anchored to the reinforcement. The waterstops are fixed to the edge anchors with the special waterstop clip or, in the case of waterstops with steel plates (FMS, FS) to the edge perforation of the steel plates at maximum intervals of 25 cm.

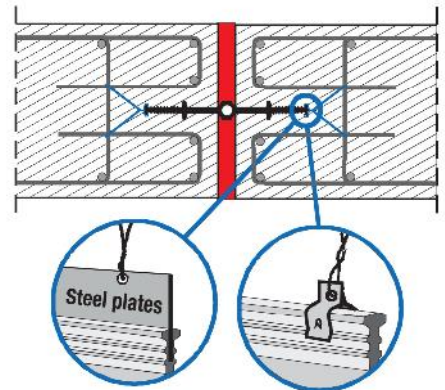

#### - Horizontal Waterstops Positioning in Slabs

To prevent honeycombing or concreting voids, the internal waterstops in bases and decks should be installed in a v-shape at an angle of about  $\geq 15^{\circ}$  upwards.

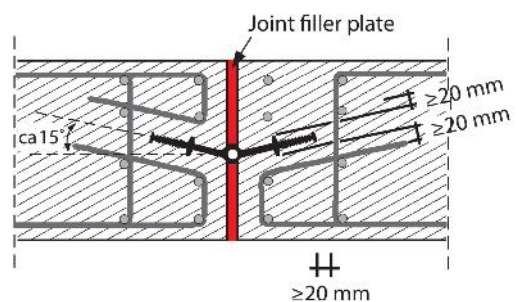



### - Spacing Between Joints in the Waterstops Themselves

The spacing between two joints in the waterstops themselves should be 0.50 m minimum. In every configuration the length of the free waterstop ends should be 1.00 m minimum so that these connection joints can be formed easily and correctly on site.

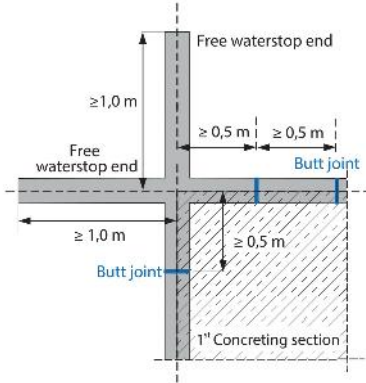

### - Tight Bulkhead Formwork

When installing the waterstop system, ensure that the bulkhead formwork is tight, stable and immovable. The stopend formwork must lie tight against the waterstops. The waterstop must be protected from damage before and during the concreting works.

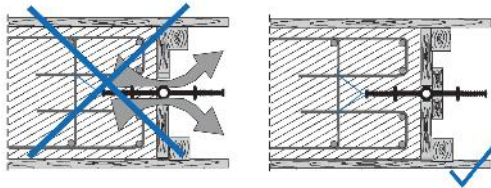

### During the Concreting Works:

#### - Embedding of External Waterstops

Waterstops must be free from contamination and ice when casted in. If necessary they should be cleaned before concreting (e.g. removal of any accumulated site debris such as sawdust, sand, concrete residues, cement laitance, oil, grease, snow, ice etc.). This is particularly important for external waterstops in the base of a structure.

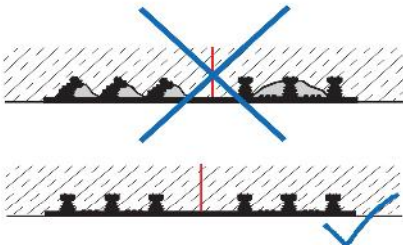

### During the Concreting Works:

#### - Embedding of External Waterstops

Waterstops must be free from contamination and ice when casted in. If necessary they should be cleaned before concreting (e.g. removal of any accumulated site debris such as sawdust, sand, concrete residues, cement laitance, oil, grease, snow, ice etc.). This is particularly important for external waterstops in the base of a structure.

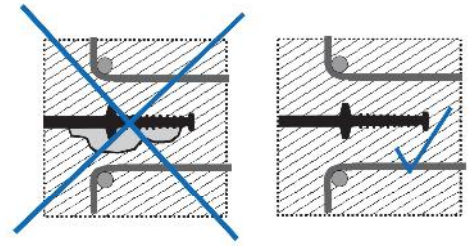

### - Clearance Between Poker Vibrators and Waterstops

The poker vibrators must never touch the waterstop or its fixings (minimum clearance  $\geq 10$  cm). It is usually preferable to compact around external waterstops with external vibrators, which will also give better compaction around stop end anchors.

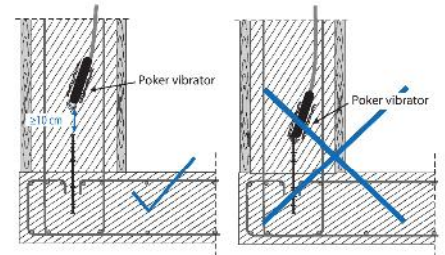

### Protection:

#### - Protection of Exposed Waterstops On Site

The waterstops should be protected from damage until they are fully casted in. Examples of suitable protective measures are:

- For waterstops in walls: cover reinforcement ends with boarding, box in or roll up and suspend the waterstop till later
- For waterstops to be trafficked: completely cover or bed in sand
- For waterstop ends to be exposed for some time: box in to fully protect

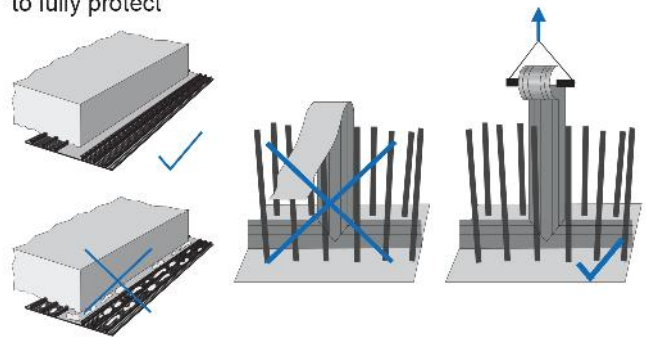

### Striking of Formwork:

#### - Striking Around External Waterstops

Take great care that external waterstops do not come loose during striking of adjacent or attached formwork. Extend the time before striking these areas if necessary.

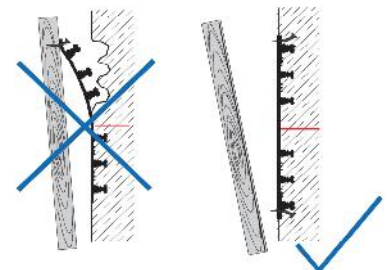

## Waterstops welding



Hot air blower welding procedure



Hot air blower welding tool

Hot air blower teflon plate



Axe-shaped welding procedure



Axe-shaped welding tool



# Hydroseal®

## High Quality Hydrophilic waterstop

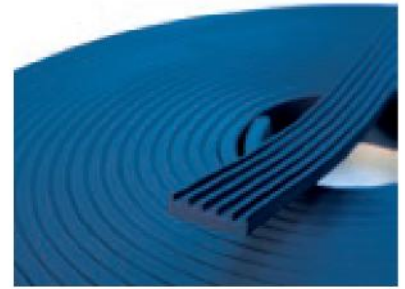

### Description

- Swellable water stop based on synthetic rubber as watertight seal for construction joints with excellent swelling capabilities. Waterseal retains its own form in multiple wet and dry cycles.
- Waterseal has good resistance to a wide range of chemicals – although we would always recommend final confirmation as to suitability in contaminated circumstances be obtained from our technical dept.
- The product remains consistent in its performance throughout its life cycle and the flexibility allows it to fill voids and cracks in the immediate surrounding area.

### Use

- Designed for the easily applied sealing of construction joints in concrete and reinforced concrete construction. Waterseal seals against non-pressing and pressing ground water up to 6 bar. Waterseal can be used in repeated wet and dry cycles.
- The joints should in all instances be square butted and tight to ensure a continuous section with a minimum of 60mm concrete cover.
- Waterseal can be applied both vertically and horizontally but under no circumstances should it be used in expansion joints.

### Application

- Can be mechanically fixed with nails at approx 300mm centres or adhered with adhesive.
- The product can be adhered to concrete, steel and PVC pipe penetrations with the adhesive.
- The adhesive will also ensure a good bond is achieved on slightly uneven surfaces.
- The use of a tying wire around Waterseal in the case of securing it to PVC pipes is also recommended in conjunction with the adhesive.

### SIZES AND PACKAGING

Size	Roll	In a box
20 x 7 mm	15 m	5 x 15 m

### Tailor-Made Waterseal

Hydrophilic waterstop can be manufactured according to customer orders with different dimensions.

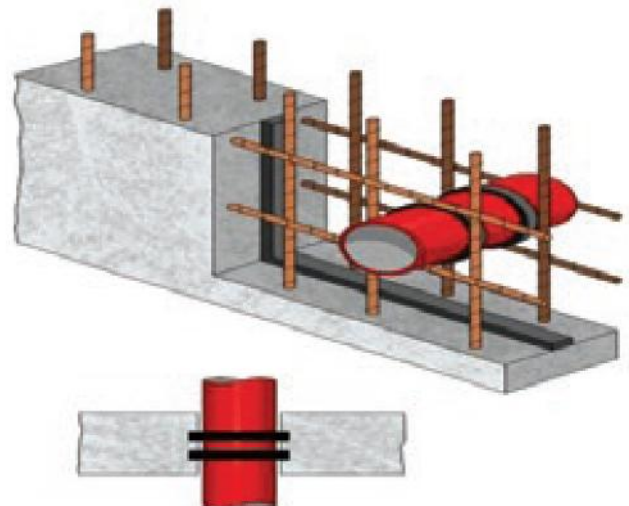

### Technical Data

Swelling capacity in concrete water	400%
Swelling capacity in rain water	500%
Colour	Blue
Hardness	35° Shore A
Tensile strenght	>2 MPa
Elongation	>400%
Density	1.22±0.03
Temperature range	-20+75°C
Weather resistance	Excellent
Chemical resistance	Good overall chemical resistance, but we advise to be careful with aromatic oils and fuels, with vegatal oils and strong aromatic solvents. Contact our sales department for detailed specific information.